

Monteringsveiledning  
Rullegardin - UNIG med kjedetrekk og evt. type 2 profil  
Nr. 1.22

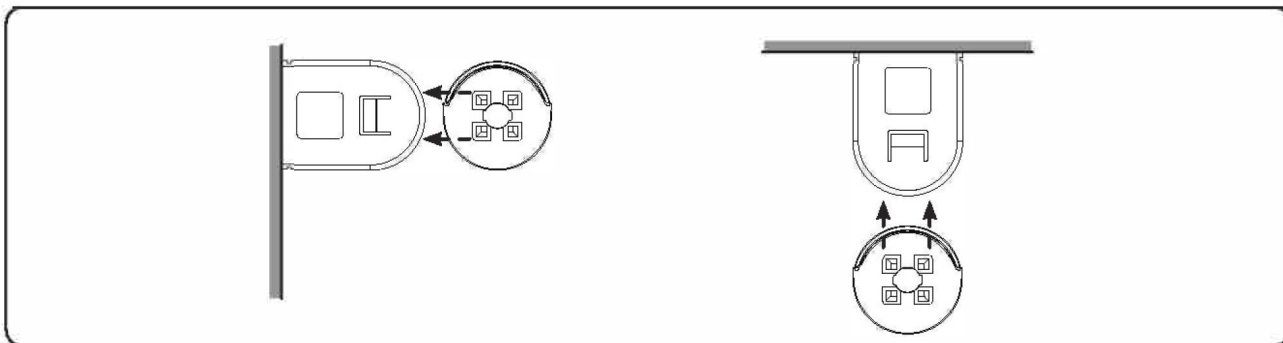

## Montering

Beslaget skal monteres slik at yttersidene har samme breddemål som det breddemålet du har opplyst ved bestilling.

1

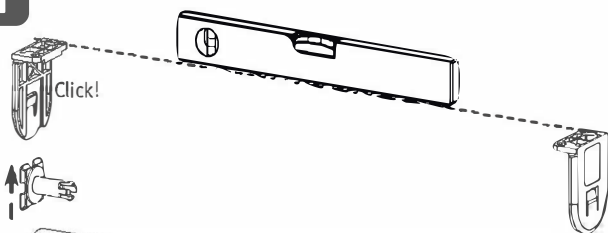

2

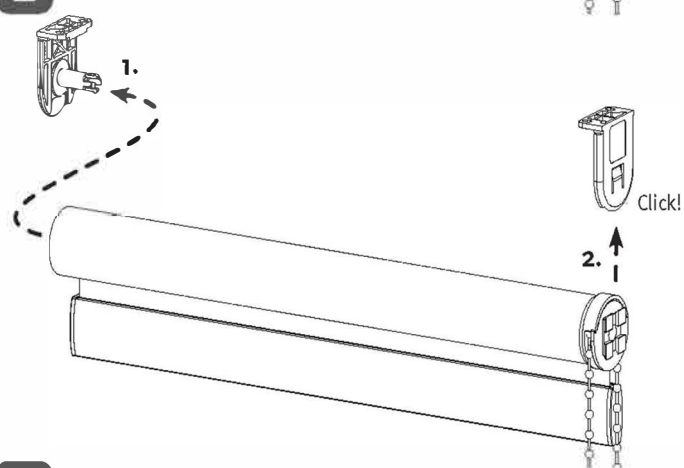

3

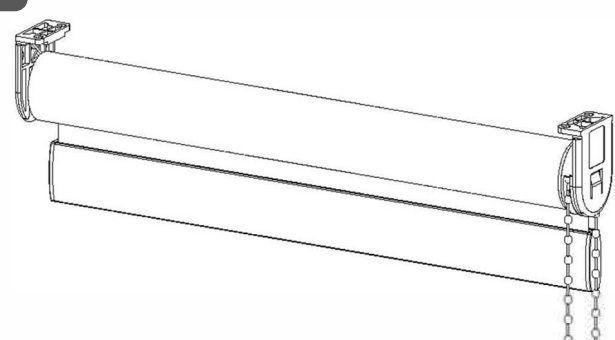

## Montering med beslag til plastvinduer

1. Avstanden mellom klemmebeslagene på vindusrammen finnes, og beslagene skrues fast.
2. Heng wire med låsering opp i henholdsvis holder eller klemmebeslag. Avkort wiren under låseringen til ønsket lengde. Korrigjer ved å forskyve låseringens wirespennning. Stram låseringen. Skyv opp avdekningen.

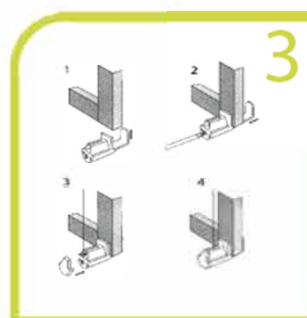
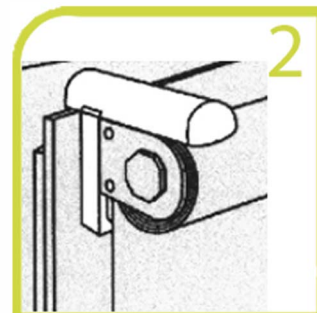
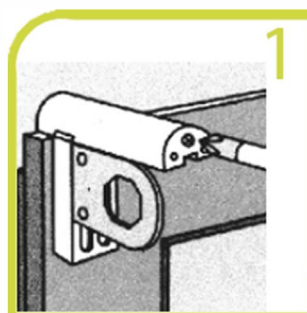

# Monteringsveiledning til rullegardin type 2



## Montering med clips/vinkelbeslag

Ved montering med clips el. vinkelbeslag til profilbeslag må du sikre deg at avstanden mellom beslaget og enden av rullegardinen utgjør minimum 50-150 mm.

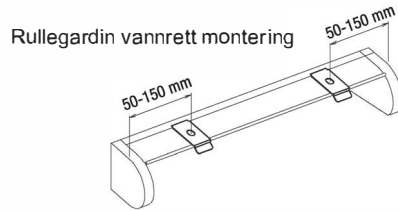

### Veggmontering med clip

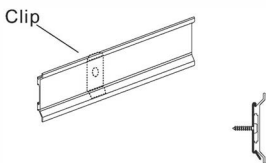

### Takmontering med clip

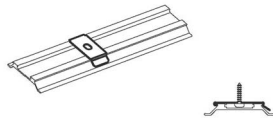

## Clips inn rullegardinen

### Sett opp for veggmontering

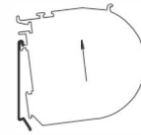

Klik på plads

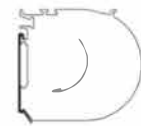

### Sæt op til loftmontering



Klik på plads



## fjerne

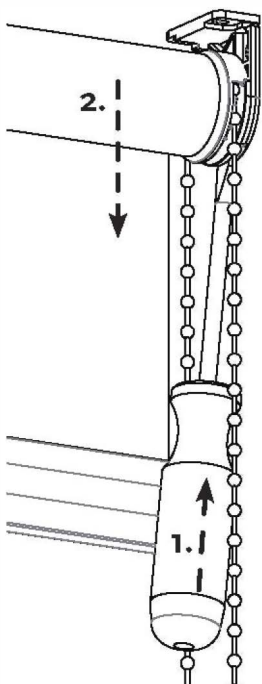
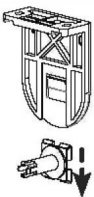

## Avmontering

Hvis rullegardinen skal avmonteres igjen, føres en liten skruetrekker ind i skyvestykket for å løsne det fra rullen.

Har du bruk for ytterligere veiledning?

Monteringsvideo <https://www.youtube.com/watch?v=QD3LprZgAvc>

Justering av rullegardin: <https://www.youtube.com/watch?v=WkvkUbpAqCk>

Tilslutning av motor: <https://www.youtube.com/watch?v=uo9uXOPReZ0>

Justering af kjede till rullegardin: <https://www.youtube.com/watch?v=QK7jqnhERTQ>

Hvis du opplever problemer med din rullegardin, så kan du finne svar på ofte stilte spørsmål her:

<http://www.uniggardin.no/content/17-faq-rullegardiner>